

PDF FICHE TECHNIQUE

POLO-ECO plus PREMIUM – Branchement 200/160/90°

N° article 06458

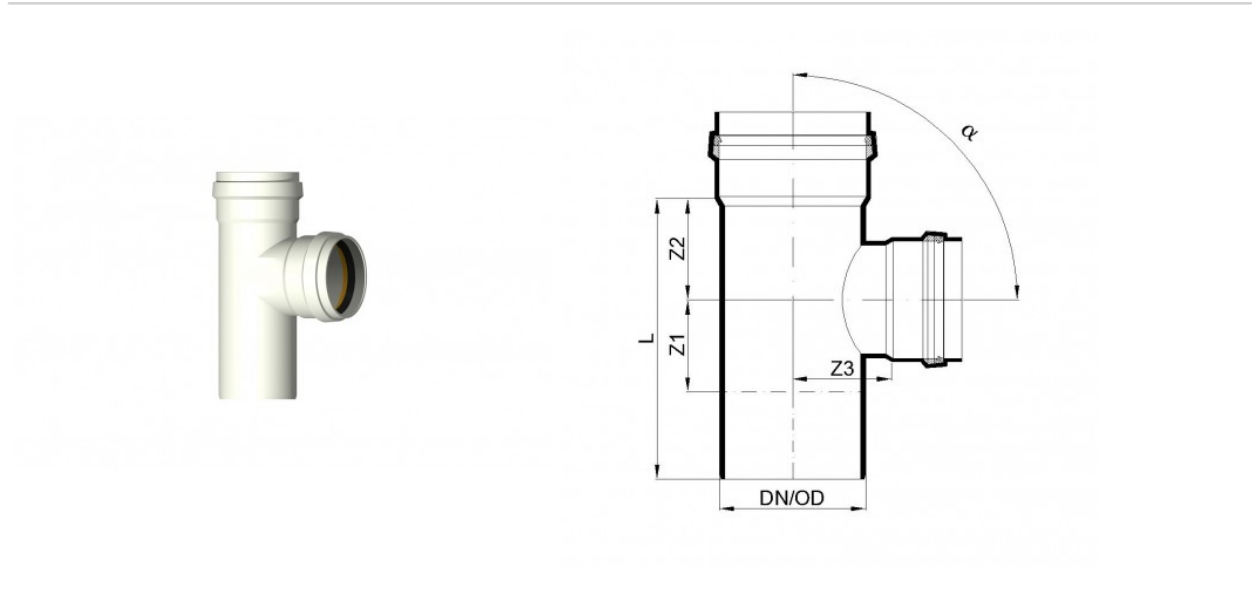
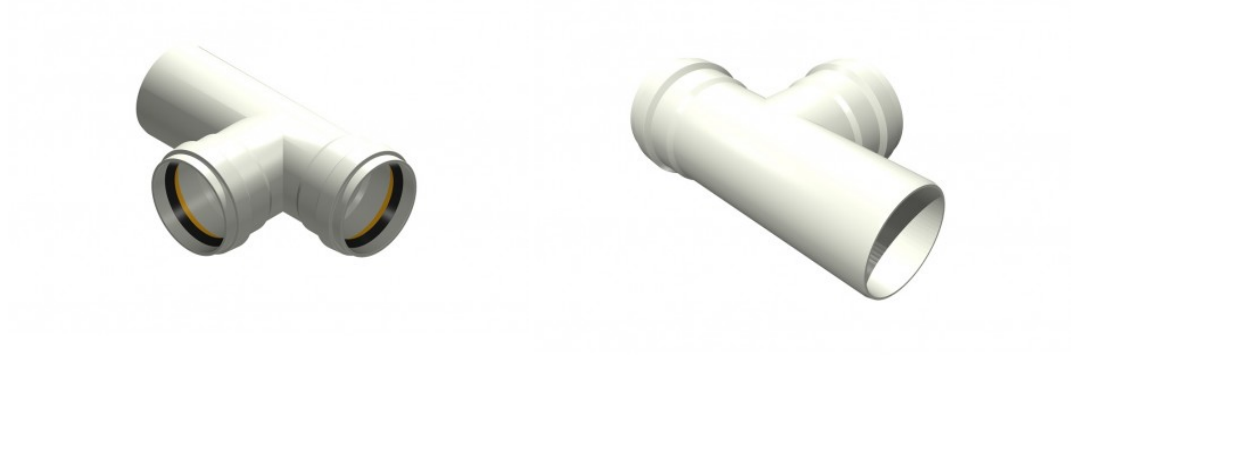

Fiche technique

DN/OD	200
DN/OD2	160
Angle α	90°
Longueur L	383 mm
Z1	126 mm
Z2	138 mm
Z3	135 mm
Poids	5,40 kg/u.
Unité d'emballage	1 u.