

# PDF FICHE TECHNIQUE

## POLO-ECO plus PREMIUM – Branchement 200/125/45°

N° article 06407

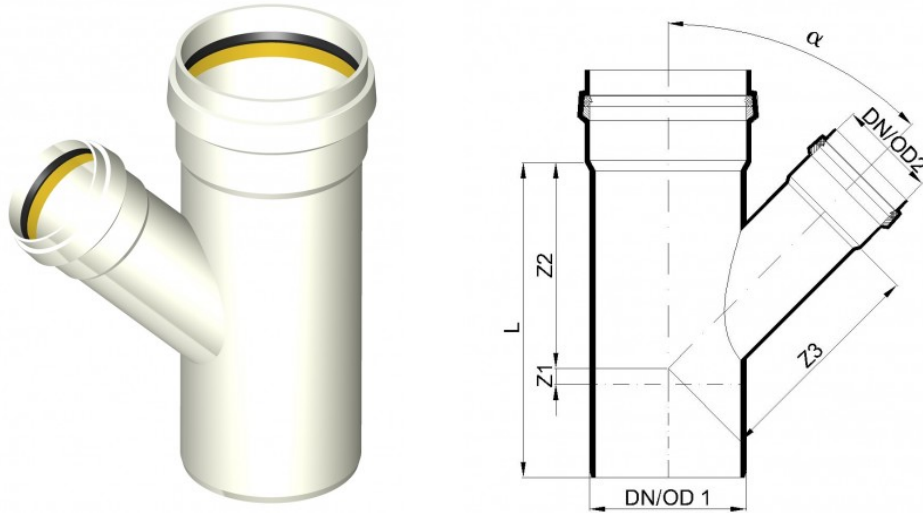

PURE  
PROGRESS / poloplast

### Fiche technique

DN/OD	200
DN/OD2	125
Angle $\alpha$	45°
Longueur L	402 mm
Z1	20 mm
Z2	263 mm
Z3	282 mm
Poids	2,60 kg/u.
Unité d'emballage	1 u.