

PDF FICHE TECHNIQUE

POLO-ECO plus PREMIUM – Coude 200/30°

N° article 06332

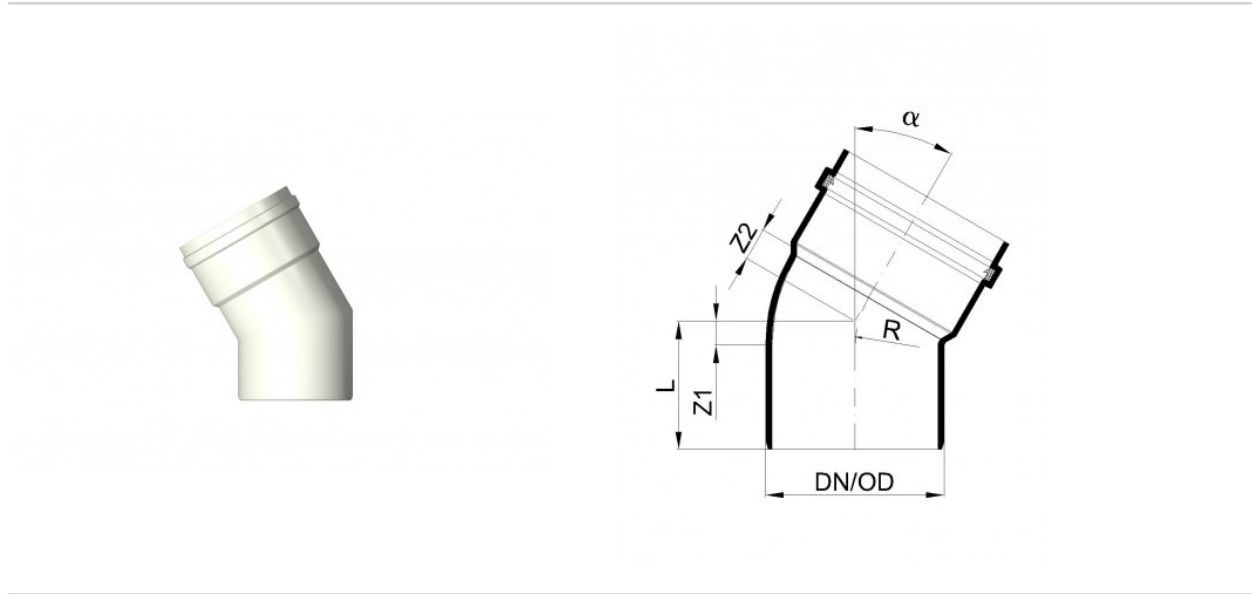

Fiche technique

DN/OD	200
Angle α	30°
Longueur L	144 mm
Z1	27 mm
Z2	37 mm
Poids	1,70 kg/u.
Unité d'emballage	1 u.