

PDF FICHE TECHNIQUE

POLO-ECO plus Premium – Branchement 250/250/90°

N° article 06464

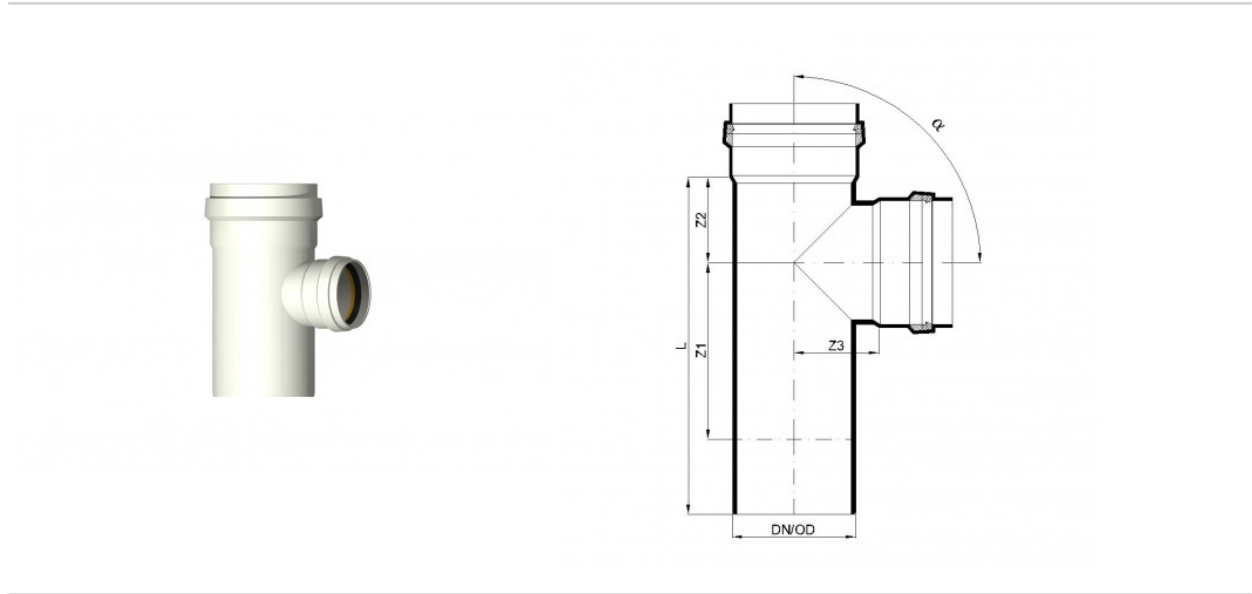

Fiche technique

DN/OD	250
DN/OD2	250
Angle α	90°
Longueur L	680 mm
Z1	358 mm
Z2	173 mm
Z3	172 mm
Poids	10,70 kg/u.
Unité d'emballage	1 u.